

**HNITATAFLA - GRAFTARBOTN**

NR	X-hnit	Y-hnit
101	352977.3088	396522.1796
102	353011.2899	396533.4247
103	353016.8227	396532.2979
104	353021.0275	396528.5295
105	353027.1526	396510.0305
106	353010.7730	396504.6102
107	353006.6155	396517.1733
108	352996.2199	396513.7332
109	353002.8489	396493.7015
110	352988.3236	396488.8948

**HNITATAFLA - HÚS**

NR	X-hnit	Y-hnit
111	352979.4569	396521.0997
112	353011.3942	396531.6686
113	353016.0316	396530.7241
114	353019.5558	396527.5656
115	353025.0076	396511.1094
116	353011.8528	396506.7582
117	353007.6954	396519.3213
118	352994.0719	352994.0719
119	353000.7009	396494.7814
120	352989.4034	396491.0428

YFIRLITSMYND  
1:200

**SKÝRINGAR**  
ÖLL MÁL ERU í m. HNIT ERU Í ÍSNET93 OG HÆDARKÓTAR Í HÆDARKERFI REYKJAVÍKUR

**ÚTGÁFUFERILL**

ÚTG.	DAGS.	SKÝRINGAR	HANNAÐ	YFIRF.	SAMB.
01	22.11.2024	VERKTEIKNING	AP	BS	AMS

DAGS. UNDRISKRIFTAR	F.H. MANNVITS (NAFN OG KT.)
22.11.2024	Andri Martin Sigurðsson, kt: 170583-4429 anmsn@cowi.com
DAGS. UNDRISKRIFTAR	SAMRÆMINGARHÖNNUÐUR / HÖNNUNARSTJÓRI (NAFN OG KT.)
22.11.2024	Andri Martin Sigurðsson, kt: 170583-4429 anmsn@cowi.com

BYGGT Á ADALUPPDRAÐTUM - DAGS.: 11.06.2024 - ÚTGÁFA: 01



**COWI**  
Urðarhvarfi 6 203 Kópavogi Sími: 422 3000  
www.cowi.com cowi\_is@cowi.com Kt.: 430572-0169

HEITI VERKS  
**COLAS ÞJÓNUSTU- OG STARFSMANNAHÚS  
GULLHELLA 1  
221 - HAFNARFJÖRÐUR**

FRUMÚTGÁFA	22.11.2024	FRUMÚTGÁFA	22.11.2024	STÆRD	A1
VERKNÚMÉR	2.110.192	VERKHLUTI	000	TEIKNINGANÚMÉR	GDR-1001
ÚTGÁFA	01				

PRENTAD: laugardagur, 23. nóvember 2024 13:26:26

TOLVUS664\_S2-vmf1101192\_HC - Skrifstofufylling Gullhella \Vinnudagur\A\B\WNNUSV.dwg

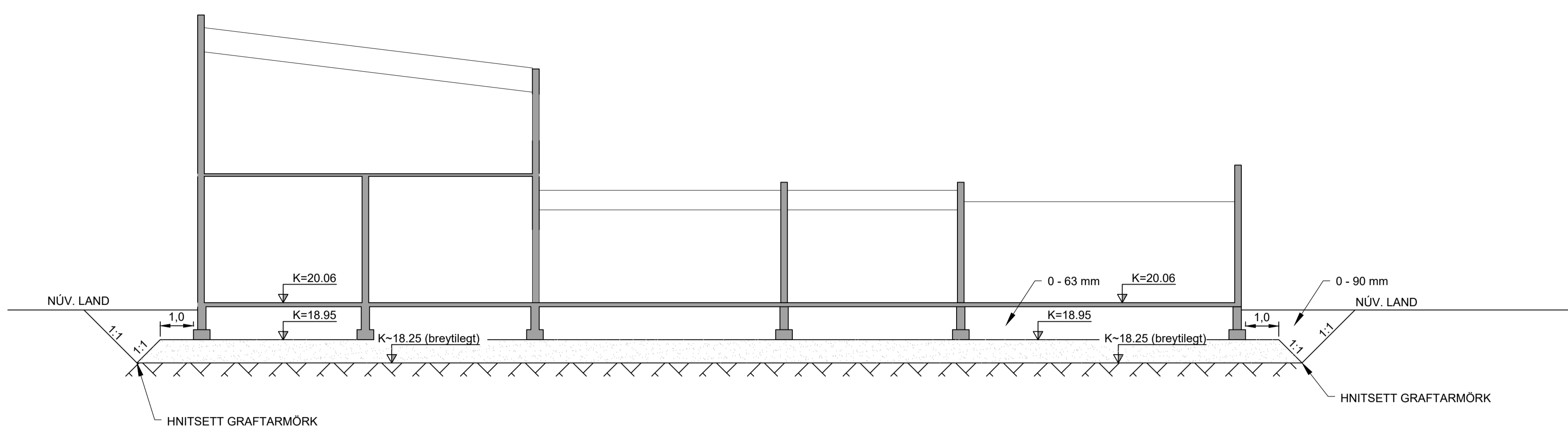

01 SNID 1001 1:100

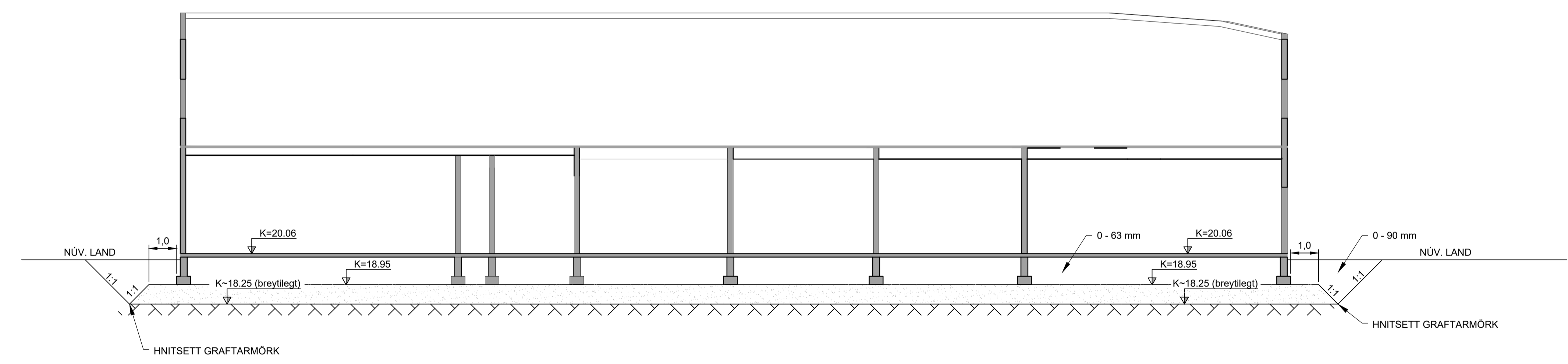

02 SNID 1001 1:100

SKÝRINGAR ÖLL MÁL ERU Í m. HNIT ERU Í ISNET93 OG HÆDARKÓTAR Í HÆDARKERFI REYKJAVÍKUR

0m 2m 4m 6m 8m 10m 1:100 (A1)

ÚTGÁFUFERILL					
ÚTG.	DAGS.	SKÝRINGAR	HANNAÐ	YFIRF.	SAMB.
01	22.11.2024	VERKTEIKNING	AP	BS	AMS

DAGS. UNDIRSKRIFTAR	F.H. MANNVITS (NAFN OG KT.)
22.11.2024	Andri Martin Sigurðsson, kt: 170583-4429 anmsn@cowi.com
DAGS. UNDIRSKRIFTAR	SAMRÆMINGARHÖNNUÐUR / HÖNNUNARSTJÓRI (NAFN OG KT.)
22.11.2024	Andri Martin Sigurðsson, kt: 170583-4429 anmsn@cowi.com

BYGGT Á ADALUPPDÁTTUM - DAGS: 11.06.2024 - ÚTGÁFA: 01



COLAS ÞJÓNUSTU- OG STARFSMANNAHÚS GULLHELLA 1 221 - HAFNARFJÖRÐUR

HEITI VERKS JARÐVINNA FYLLING OG GRÖFTUR GRAFTARSNIÐ

FRUMÚTGÁFA	22.11.2024	MKV.		STÆRD	A1
VERKNÚMÉR	2.110.192	VERKHLUTI	000	TEKNINGANÚMÉR	GDR-1002
				ÚTGÁFA	01

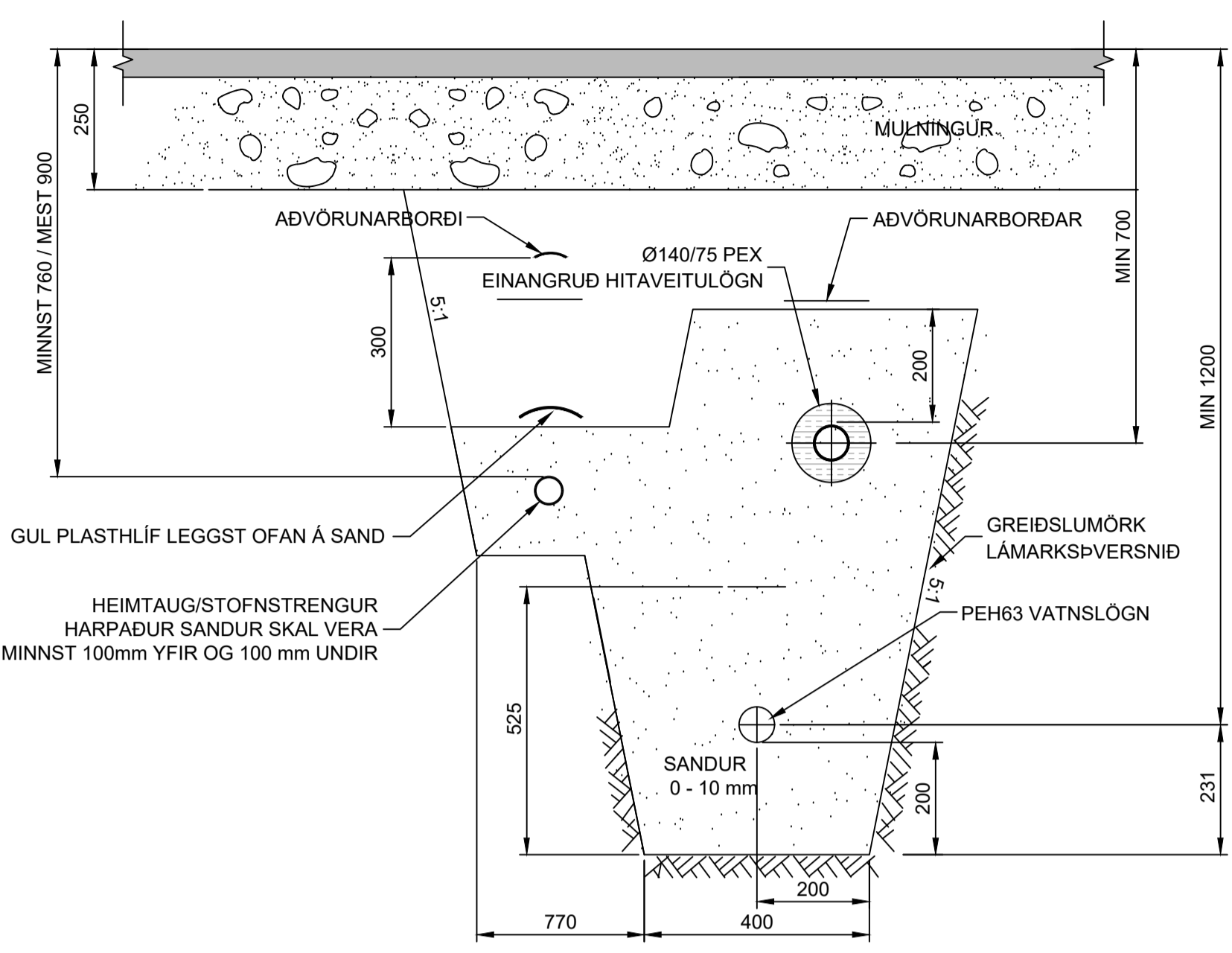

01 SNID  
2301 1:10  
1011 3S02

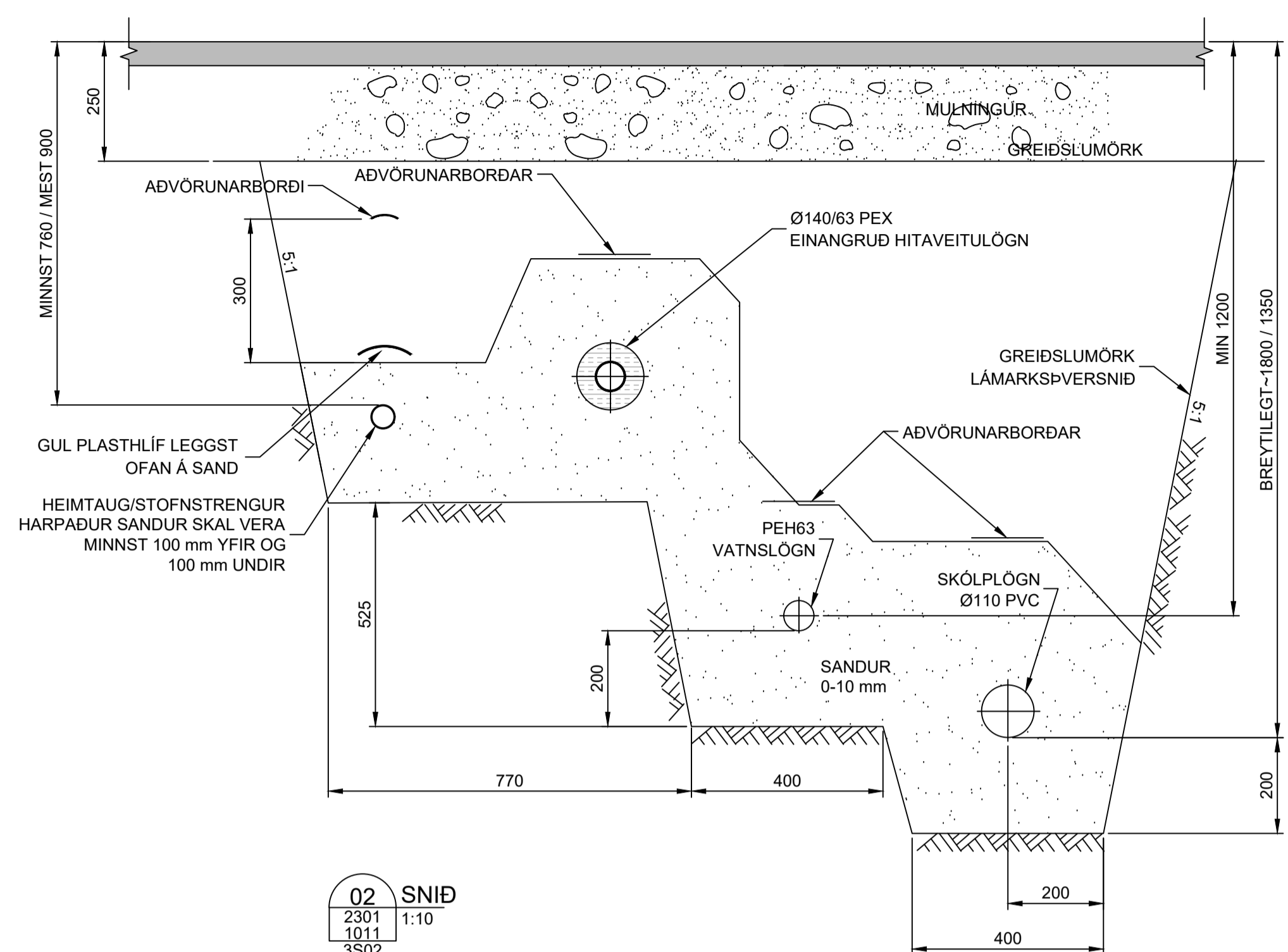

02 SNID  
2301 1:10  
1011 3S02

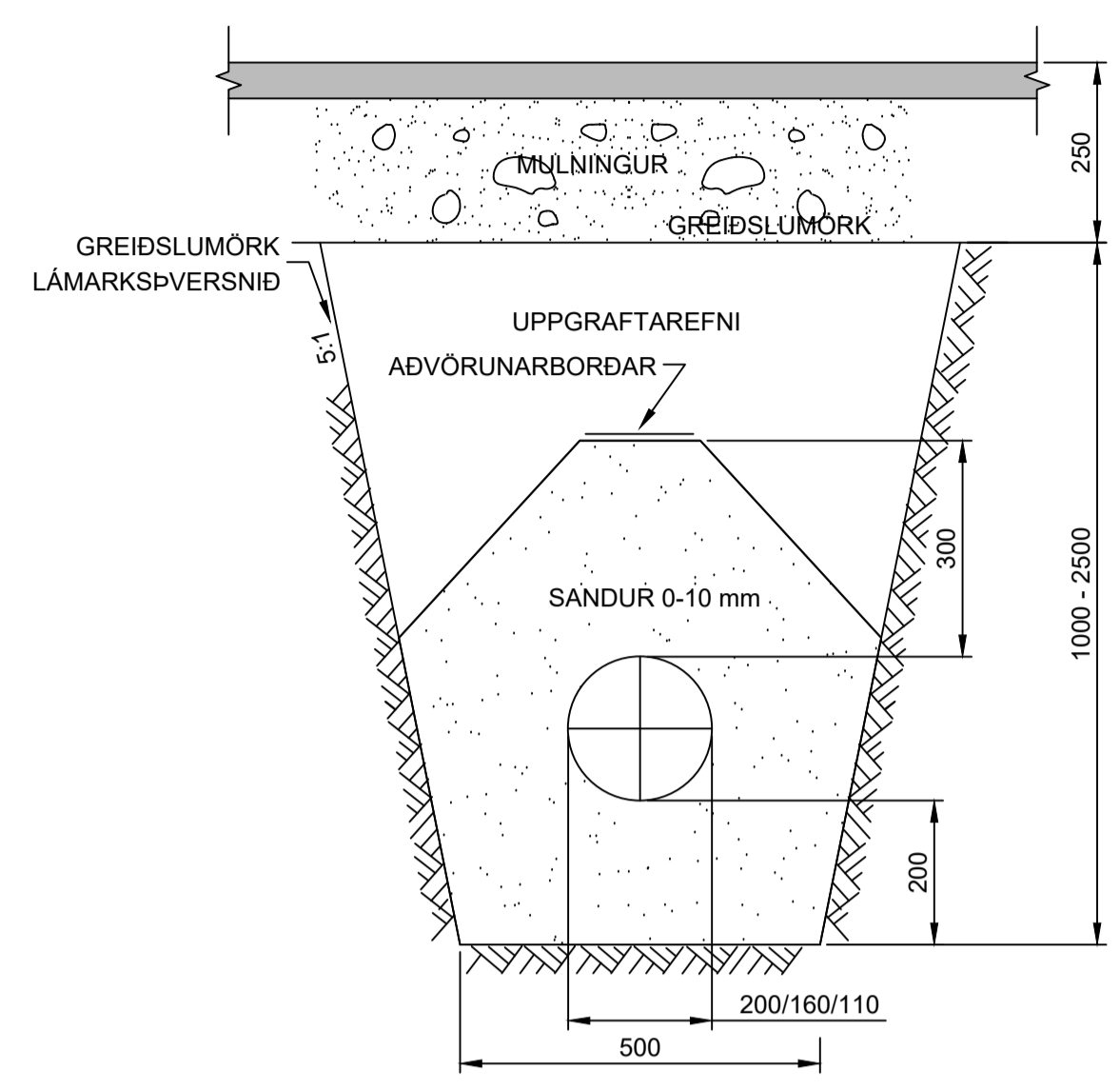

04 SNID  
1011 1:10

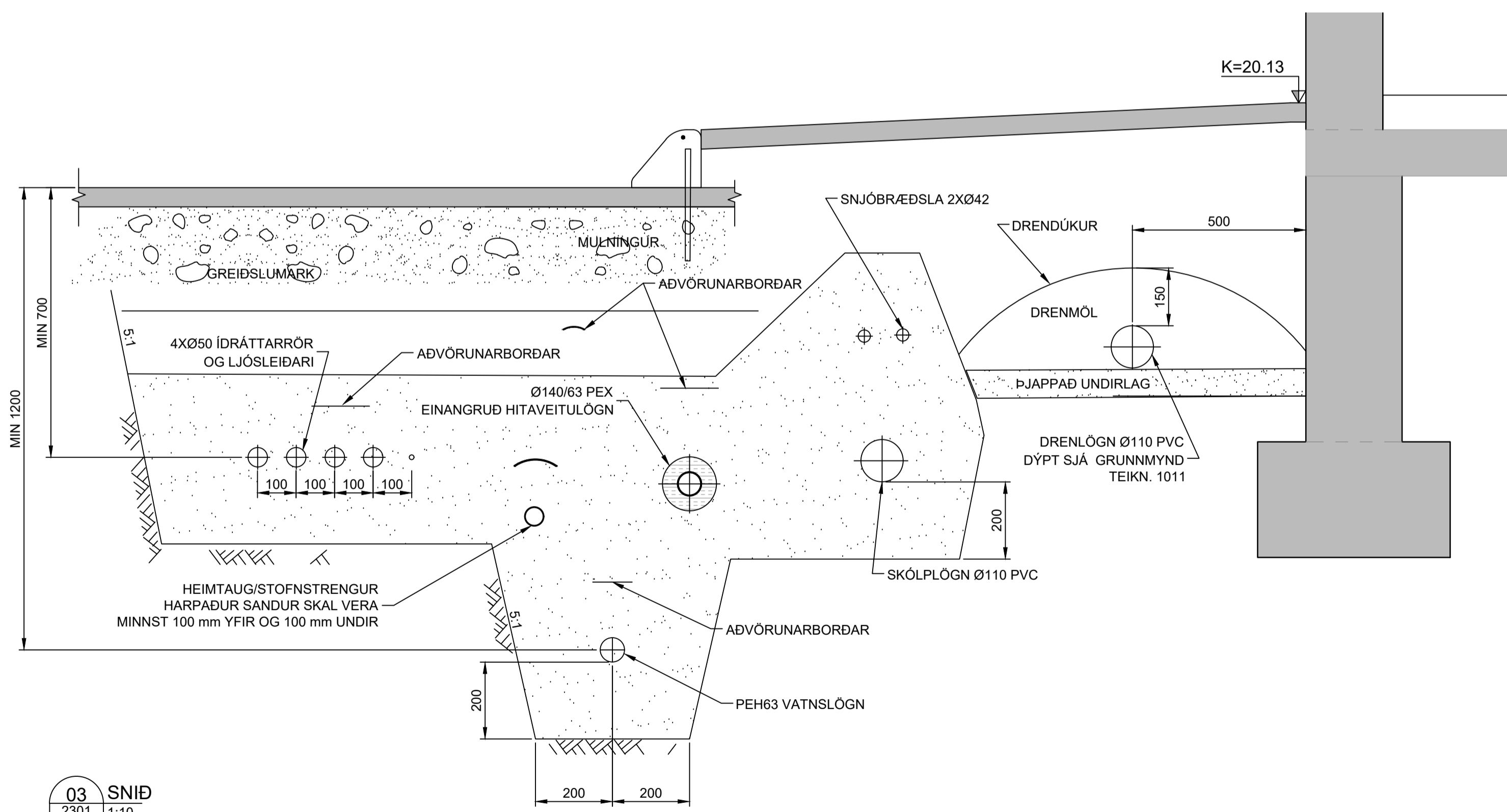

03 SNID  
2301 1:10  
1011 3S02

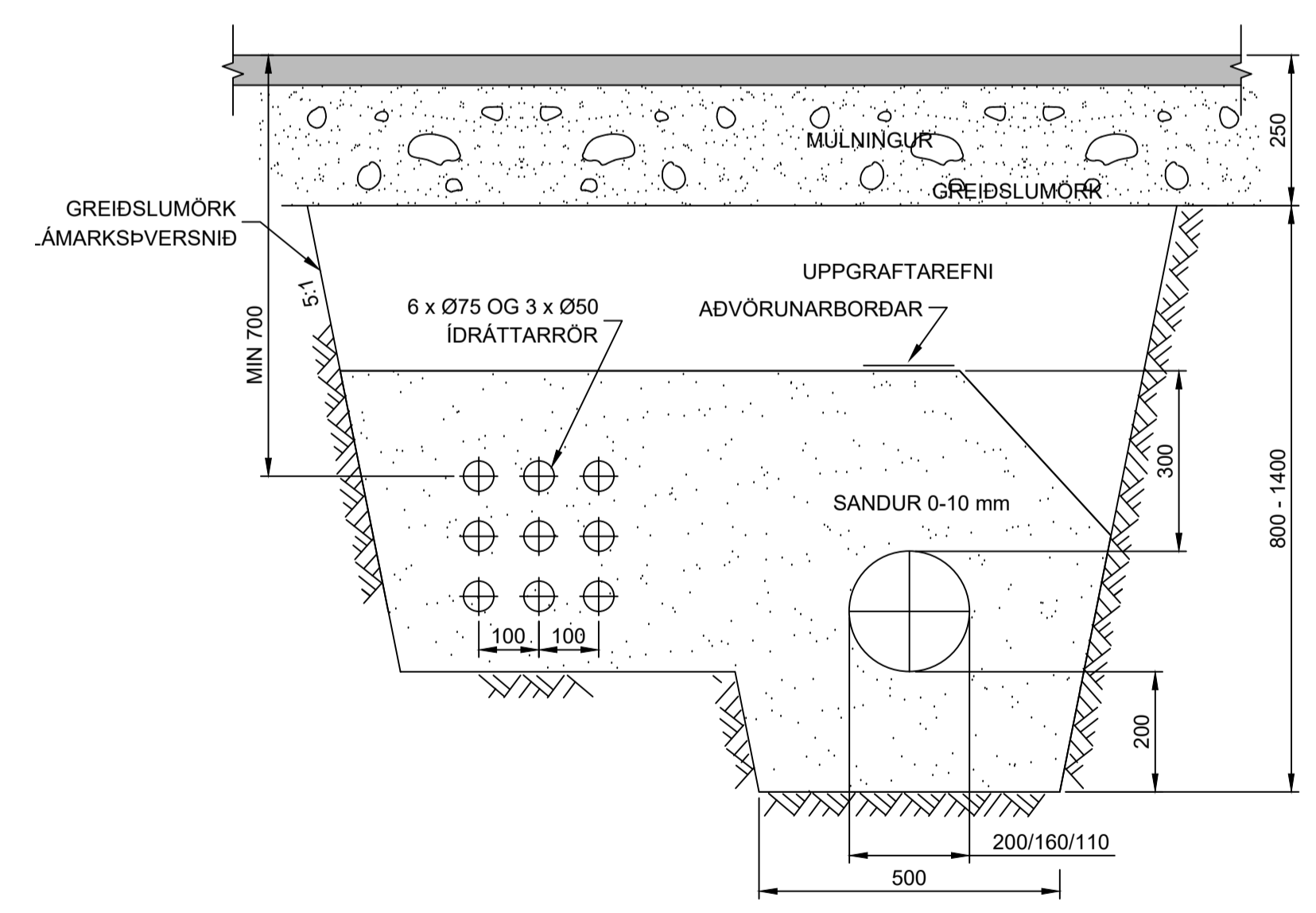

07 SNID  
2301 1:10  
1011 3S02

SKÝRINGAR

ÖLL MÁL ERU Í MILLIMETURM, NEMA ANNAD SÉ TEKID FRAM.

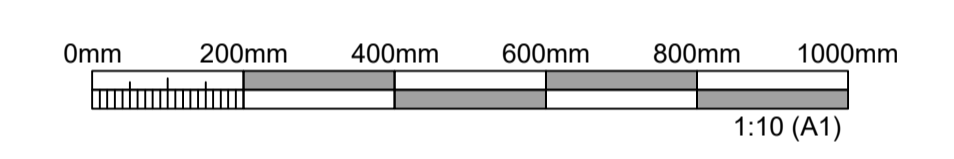

ÚTGÁFUFERILL					
ÚTG.	DAGS.	SKÝRINGAR	HANNAÐ	YFIRF.	SAMB.
01	22.11.2024	VERKTEIKNING	AP	BS	AMS

DAGS. UNDIRSKRIFTAR	F.H. MANNVITS (NAFN OG KT.)
22.11.2024	Andri Martin Sigurðsson, kt: 170583-4429 anmsn@cowi.com
DAGS. UNDIRSKRIFTAR	SAMRÆMINGARHÖNNUÐUR / HÖNNUNARSTJÓRI (NAFN OG KT.)
22.11.2024	Andri Martin Sigurðsson, kt: 170583-4429 anmsn@cowi.com

BYGGT Á ADALUPPDRATTUM - DAGS: 11.06.2024 - ÚTGÁFA: 01



Urðarhvarfi 6 203 Kópavogi Sími: 422 3000  
www.cowi.com cowi\_is@cowi.com Kt.: 430572-0169

HEITI VERKS  
COLAS ÞJÓNUSTU- OG STARFSMANNAHÚS  
GULLHELLA 1  
221 - HAFNARFJÖRÐUR

FRUMÚTGÁFA	MKV.	STERD
22.11.2024		A1
VERKNÚMÉR	VERKHLUTI	TEIKNINGANÚMÉR
2.110.192	000	GDR-1003
		ÚTGÁFA
		01

PRENTAD: laugardagur, 23. nóvember 2024 13:27:20

TOLVUS664\_S12.vmf1101192\_HC - Skrifstofubýgging Gullhella \\VrumundpurA\B\WNNUSV.dwg

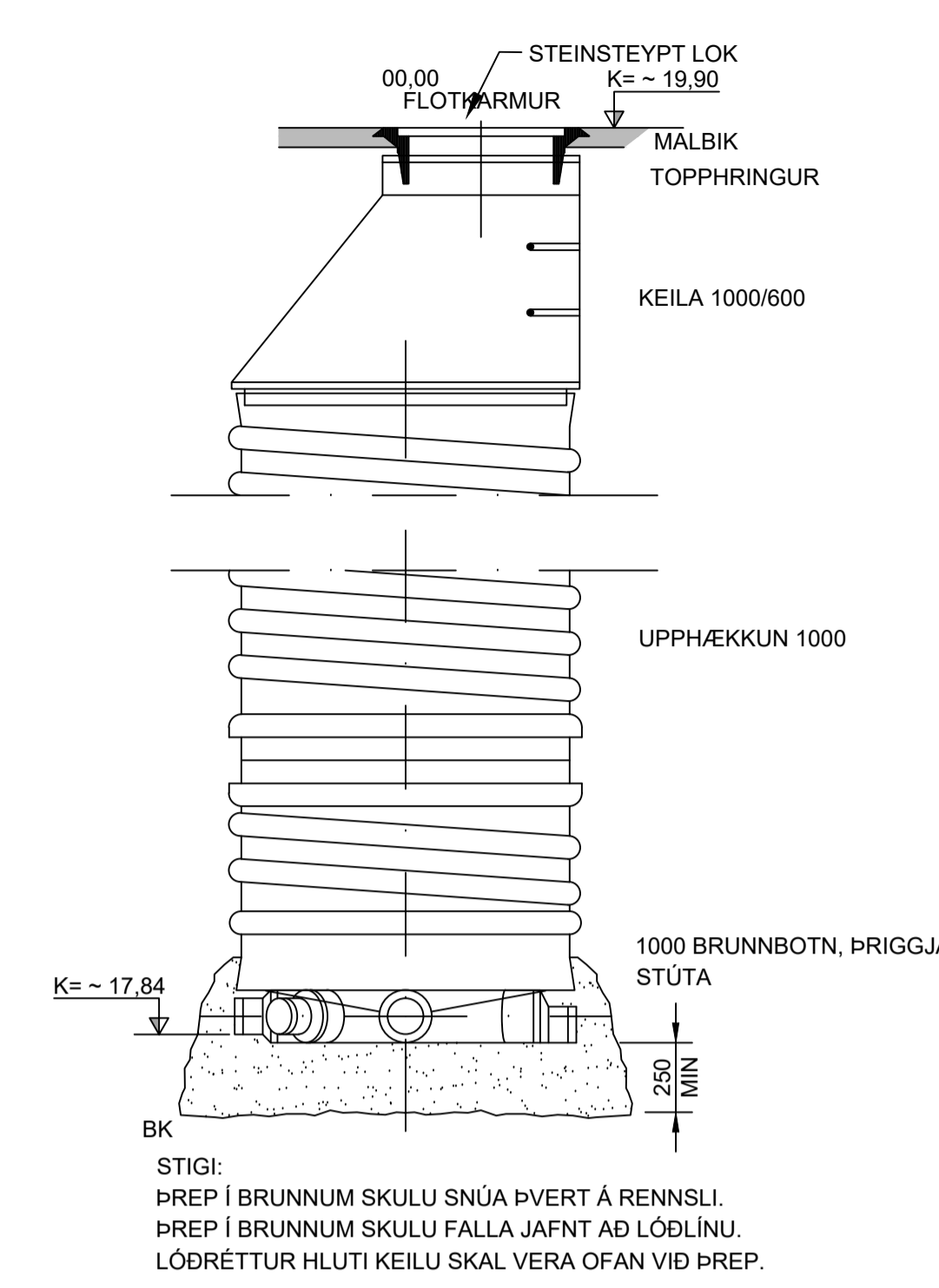

05 SNID - PASTBRUNNUR Ø1000  
1011 1:20

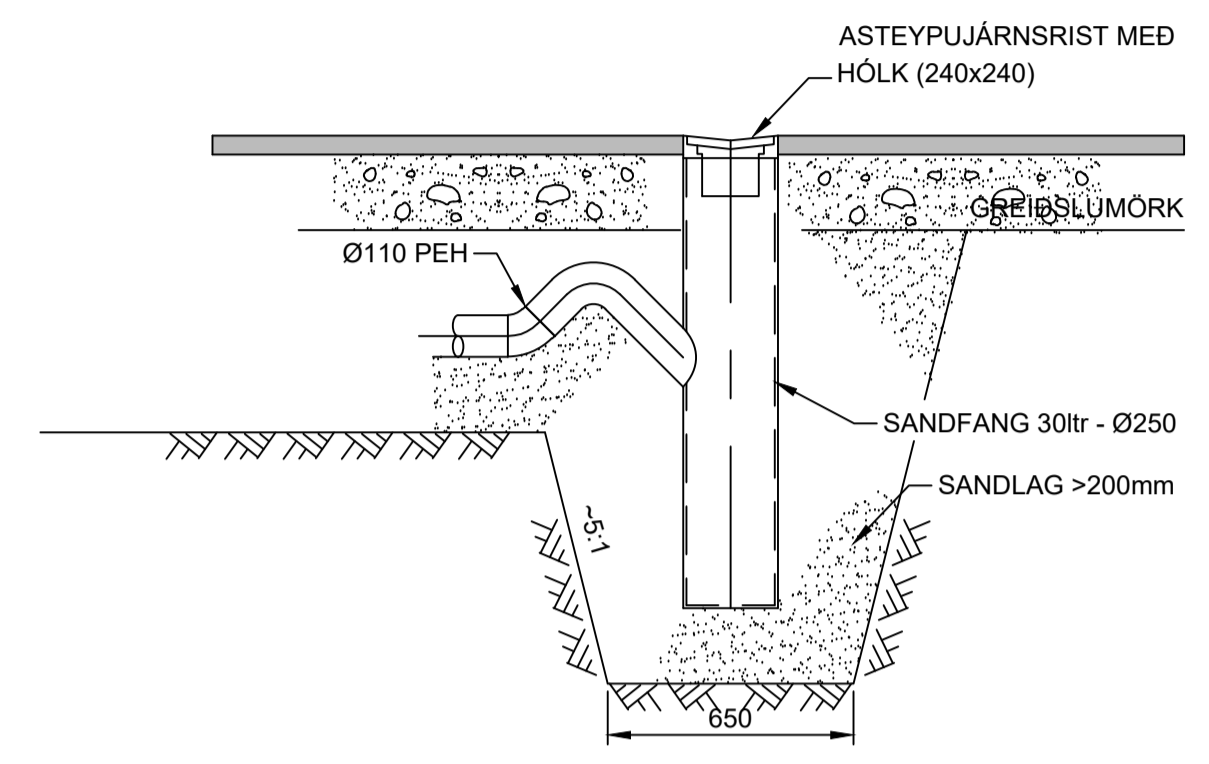

FRÁGANGUR NIÐURFALLA  
1:20

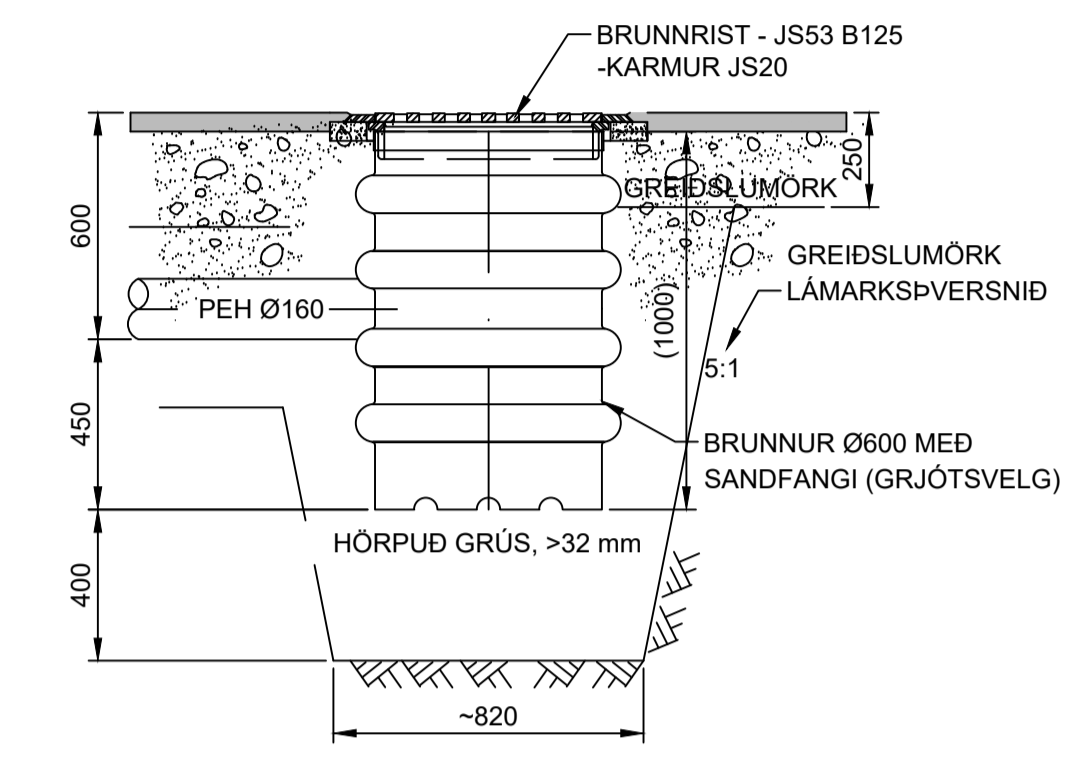

FRÁGANGUR BRUNNA  
1:20

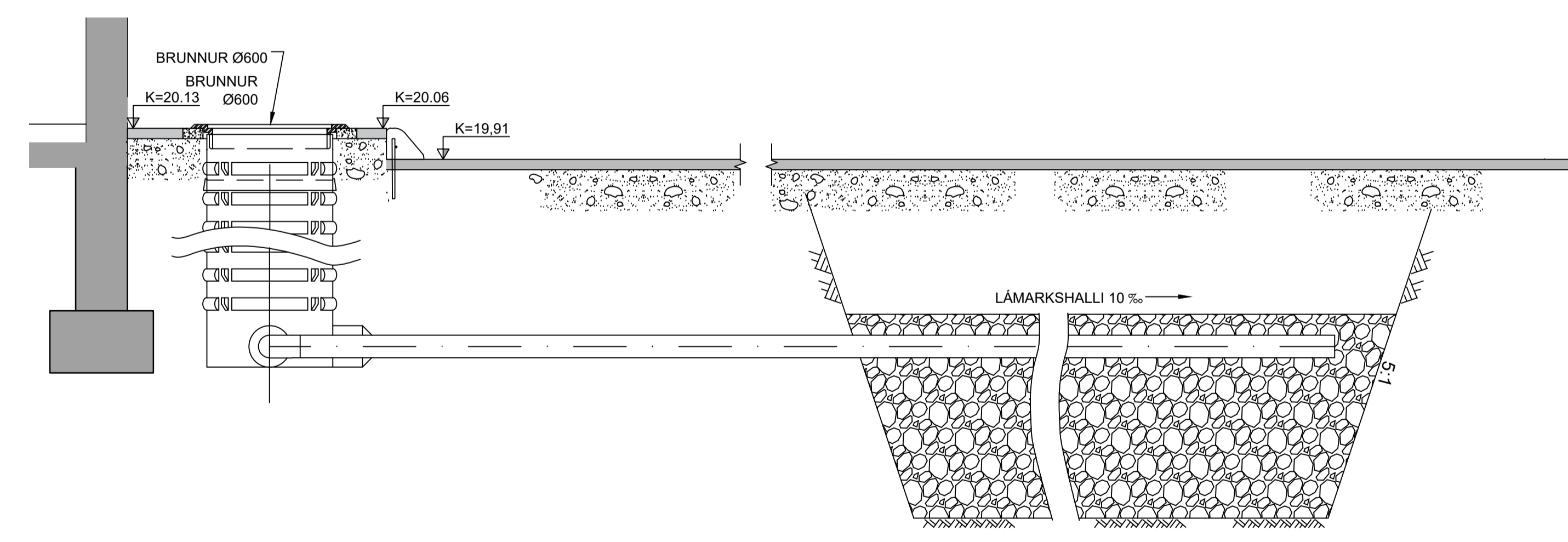

06 SNID  
1011 1:20

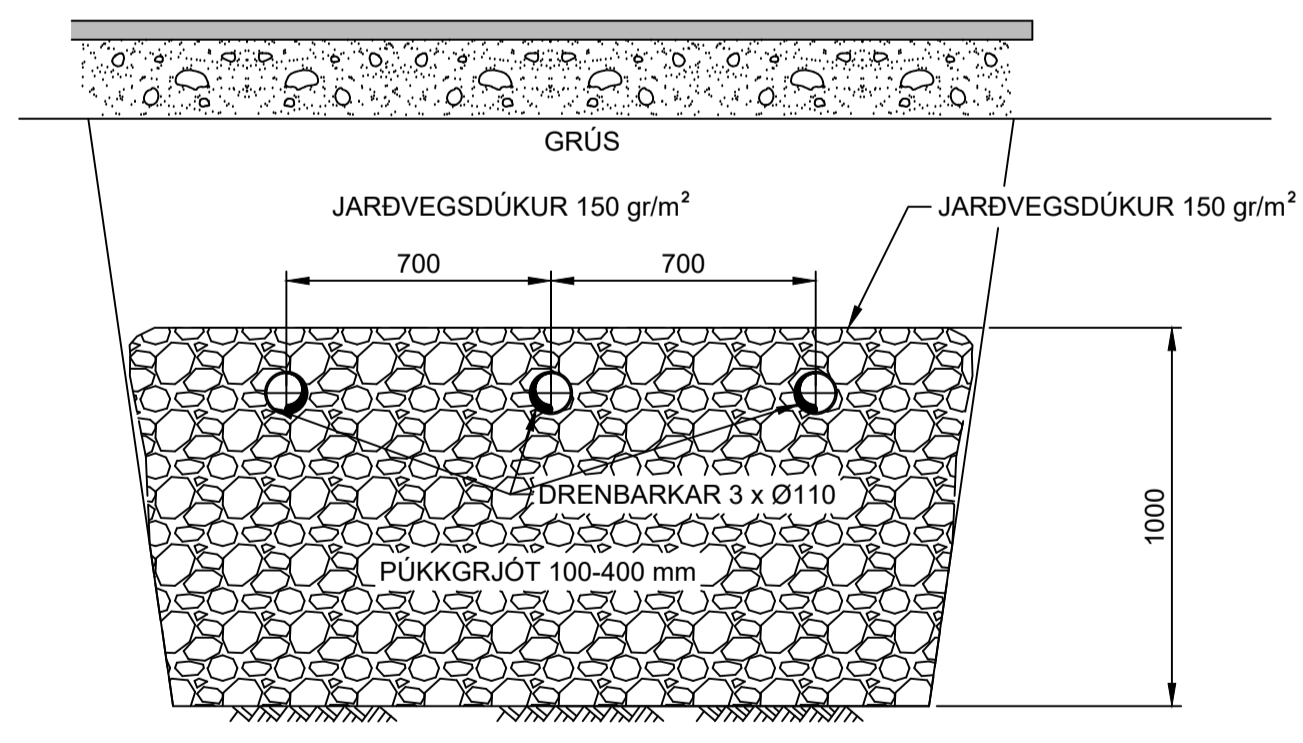

ÞVERSNIÐ Í PÚKK  
1:20

SKÝRINGAR

ÖLL MÁL ERU Í MILLIMETURM, NEMA ANNAD SÉ TEKID FRAM.  
KÖTAR Í HÆÐARKERFI REYKJAVÍKUR

0mm 400mm 800mm 1200mm 1600mm 2000mm  
1:20 (A1)

ÚTGÁFUFERILL					
ÚTG.	DAGS.	SKÝRINGAR	HANNAÐ	YFIRF.	SAMB.
01	22.11.2024	VERKTEIKNING	AP	BS	AMS

DAGS. UNDIRSKRIFTAR	F.H. MANNVITS (NAFN OG KT.)
22.11.2024	Andri Martin Sigurðsson, kt: 170583-4429 anmsn@cowi.com
DAGS. UNDIRSKRIFTAR	SAMRÆMINGARHÖNNUÐUR / HÖNNUNARSTJÓRI (NAFN OG KT.)
22.11.2024	Andri Martin Sigurðsson, kt: 170583-4429 anmsn@cowi.com

BYGGT Á ADALUPPDRATTUM - DAGS.: 11.06.2024 - ÚTGÁFA: 01



HEITI VERKS  
COLAS ÞJÓNUSTU- OG STARFSMANNAHÚS  
GULLHELLA 1  
221 - HAFNARFJÖRÐUR

HEITI TEKNINGAR  
JARÐVINNA  
LAGNIR  
SKURÐSNID

FRUMÚTGÁFA	MKV.	STÆRD
22.11.2024		A1
VERKNÚMÉR	VERKHLUTI	TEKNINGANÚMÉR
2.110.192	000	GDR-1004
ÚTGÁFA		
		01

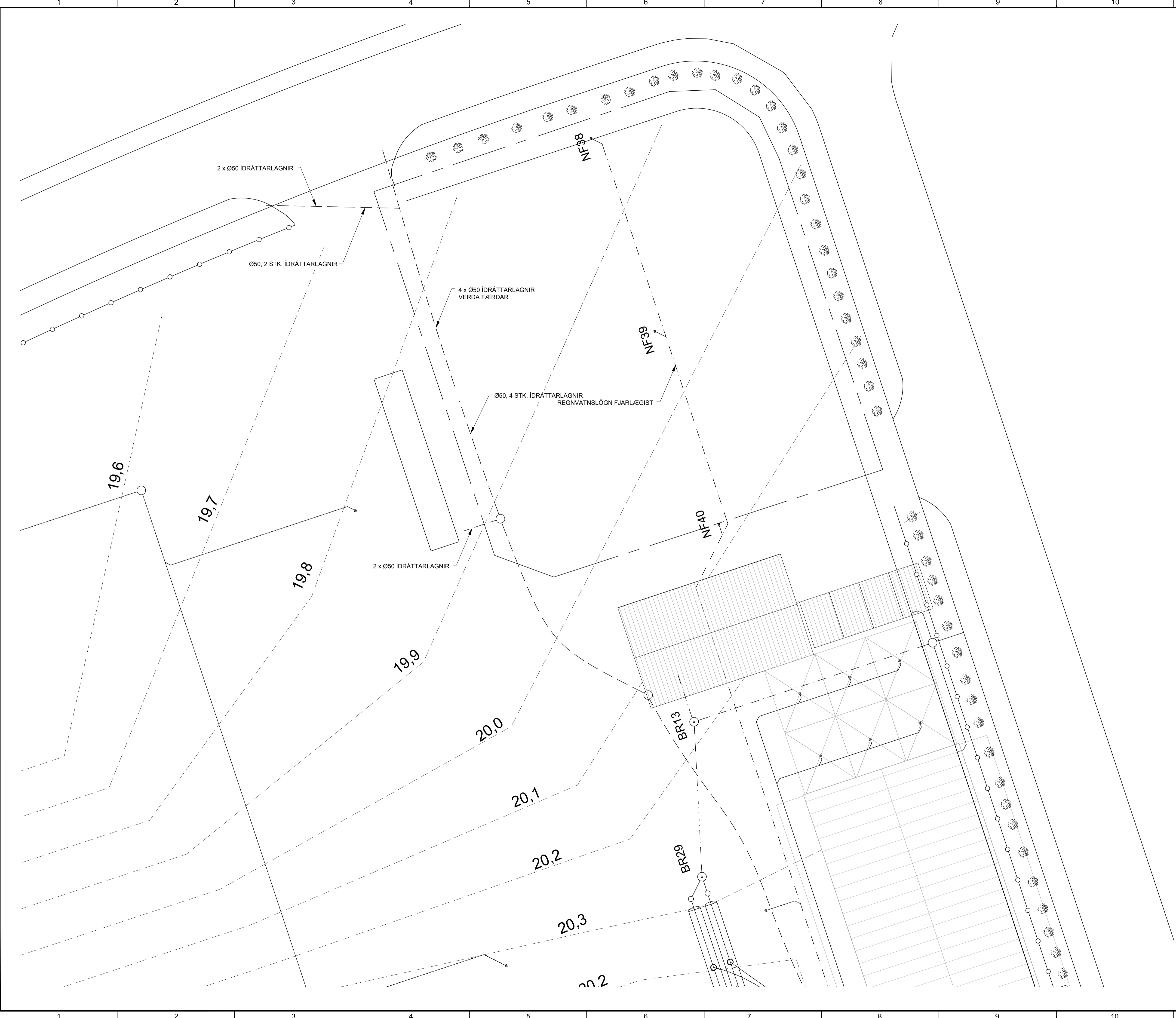

**MERKINGAR**

VERKMÖRK \_\_\_\_\_

REGNVATN \_\_\_\_\_

RAFLAGNIR \_\_\_\_\_

UPPLÝSINGAR UM AÐRAR LAGNIR INNAN ATHAFNASVÆÐIS LIGGJA EKKI FYRIR, VERKTAKI AFLI SÉR UPPLÝSINGA

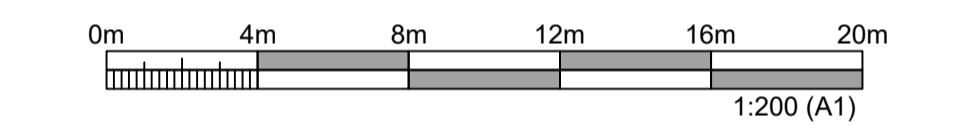

ÚTGÁFUFERILL					
ÚTG.	DAGS.	SKÝRINGAR	HANNAÐ	YFIRF.	SAMB.
01	22.11.2024	VERKTEIKNING	AP	BS	AMS

DAGS. UNDIRSKRIFTAR	F.H. MANNVITS (NAFN OG KT.)
22.11.2024	Andri Martin Sigurðsson, kt: 170583-4429 anmsn@cowi.com
DAGS. UNDIRSKRIFTAR	SAMRÆMINGARHÖNNUÐUR / HÖNNUNARSTJÓRI (NAFN OG KT.)
22.11.2024	Andri Martin Sigurðsson, kt: 170583-4429 anmsn@cowi.com

BYGGT Á AÐALUPPDRATTUM - DAGS.: 11.06.2024 - ÚTGÁFA: 01



HEITI VERKS  
**COLAS ÞJÓNUSTU- OG STARFSMANNAHÚS GULLHELLA 1**  
 221 - HAFNARFJÖRÐUR

HEITI TEKNINGAR  
 AÐSTÁÐA  
 NÚVERANDI  
 GRUNNMÝND

FRUMÚTGÁFA	22.11.2024	MKV.		STÆRÐ	A1
VERKNÚMÉR	2.110.192	VERKHLUTI	000	TEKNINGANÚMÉR	HDR-1001
				ÚTGÁFA	01

# Gullhella

## AÐKOMA COLAS

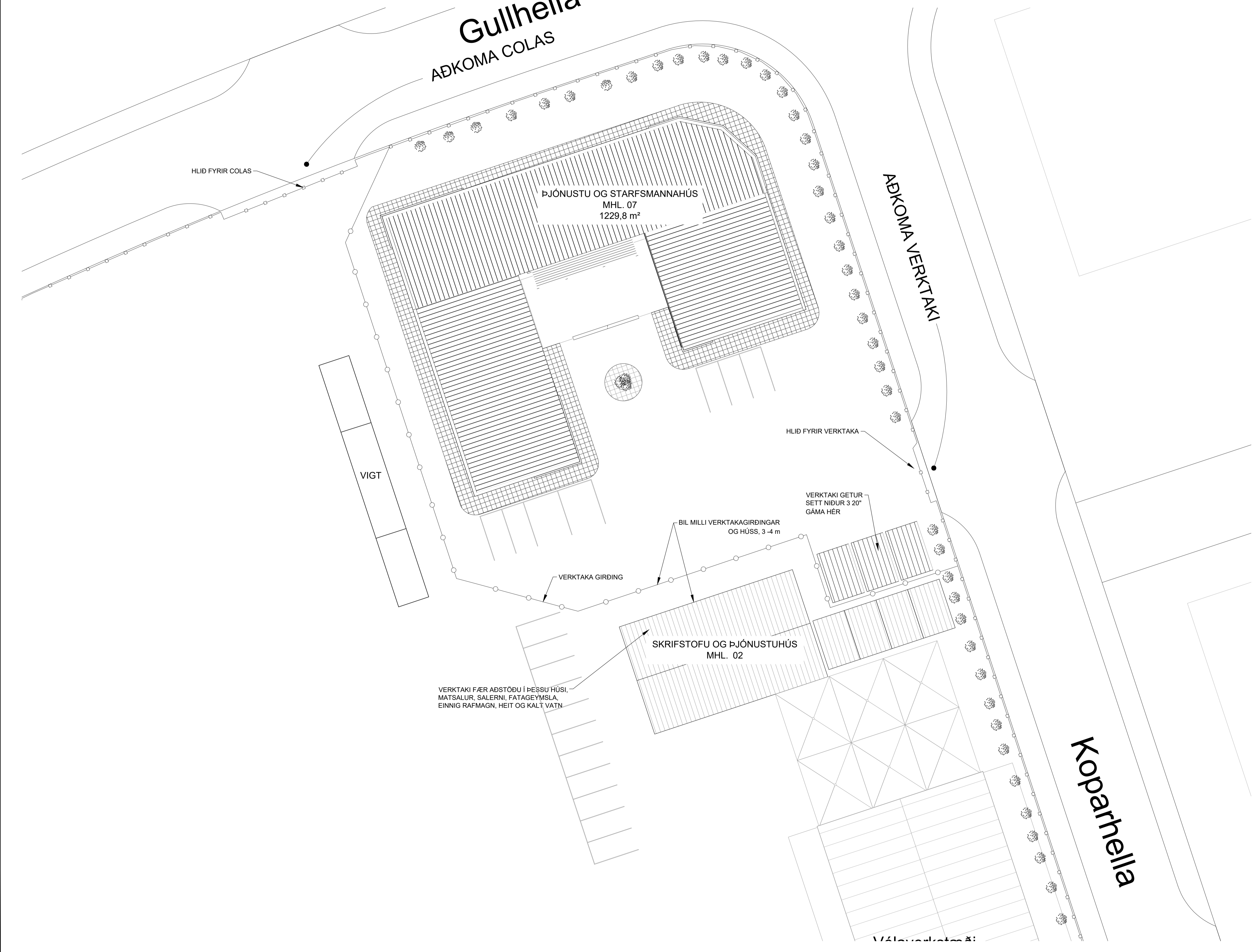

**MERKINGAR**

VERKTAKAGIRÐING 

NÜVERANDI GIRÐING 

0m 4m 8m 12m 16m 20m

1:200 (A1)

ÚTGÁFUFERILL					
ÚTG.	DAGS.	SKÝRINGAR	HANNAÐ	YFIRF.	SAMB.
01	22.11.2024	VERKTEIKNING	AP	BS	AMS

DAGS. UNDIRSKRIFTAR	F.H. MANNVITS (NAFN OG KT.)
22.11.2024	Andri Martin Sigurðsson, kt: 170583-4429 anmsn@cowi.com
DAGS. UNDIRSKRIFTAR	SAMRÆMINGARHÖNNUNUR / HÖNNUNARSTJÓRI (NAFN OG KT.)
22.11.2024	Andri Martin Sigurðsson, kt: 170583-4429 anmsn@cowi.com

BYGGT Á ADALUPPDRATTUM - DAGS: 11.06.2024 - ÚTGÁFA: 01



HÖNNUNUR

# COWI

Urðarhvarfi 6 203 Kópavogi Sími: 422 3000  
www.cowi.com cowi\_is@cowi.com Kt.: 430572-0169

HEITI VERKS  
COLAS ÞJÓNUSTU- OG STARFSMANNAHÚS  
GULLHELLA 1  
221 - HAFNARFJÖRÐUR

HEITI TEKNINGAR  
AÐSTÁÐA  
VINNUSVÆÐI VERKTAKA  
GRUNNMÝND

FRUMÚTGÁFA	22.11.2024	MKV.		STÆRÐ	A1
VERKNÚMÉR	2.110.192	VERKHLUTI	000	TEKNINGANÚMÉR	HDR-1002
				ÚTGÁFA	01



- MERKINGAR**
- VERKMÖRK \_\_\_\_\_
  - SKOLPLÖGN - - - - -
  - REGNVATN \_\_\_\_\_
  - RAFLAGNIR - - - - -
- UPPLÝSINGAR UM AÐRAR LAGNIR INNAN ATHAFNASVÆÐIS LIGGJA EKKI FYRIR, VERKTAKI AFLI SÉR UPPLÝSINGA

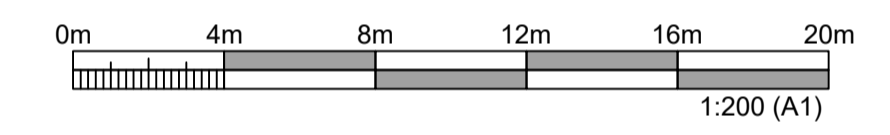

ÚTGÁFUFERILL					
ÚTG.	DAGS.	SKÝRINGAR	HANNAÐ	YFIRF.	SAMÞ.
01	22.11.2024	VERKTEIKNING	AP	BS	AMS
DAGS. UNDIRSKRIFTAR		F.H. MANNVITS (NAFN OG KT.)			
22.11.2024		Andri Martin Sigurðsson, kt: 170583-4429 anmsn@cowi.com			
DAGS. UNDIRSKRIFTAR		SAMRÆMINGARHÖNNUNUR / HÖNNUNARSTJÓRI (NAFN OG KT.)			
22.11.2024		Andri Martin Sigurðsson, kt: 170583-4429 anmsn@cowi.com			
BYGGT A AÐALUPPDRAÐTUM - DAGS.: 11.06.2024 - ÚTGÁFA: 01					



Urðarhvarfi 6 203 Kópavogi Sími: 422 3000  
www.cowi.com cowi\_is@cowi.com Kt.: 430572-0169

HEITI VERKS  
COLAS ÞJÓNUSTU- OG STARFSMANNAHÚS  
GULLHELLA 1  
221 - HAFNARFJÖRÐUR

HEITI TEIKNINGAR			
FRÁGANINGAR			
FERLAR OG AFVÖTNUN			
GRUNNMÝND			
FRUMÚTGÁFA	MKV.	STÆRD	
22.11.2024		A1	
VERKNÚMÉR	VERKHLUTI	TEIKNINGANÚMÉR	ÚTGÁFA
2.110.192	000	HDR-1003	01

**Gullhella**  
AÐKOMA COLAS

ÞJÓNUSTU OG STARFSMANNAHÚS  
MHL. 07  
1229,8 m<sup>2</sup>

AÐKOMA VERKTAKI

VIGT

SKRIFSTOFU OG ÞJÓNUSTUHÚS  
MHL. 02

Koparhella

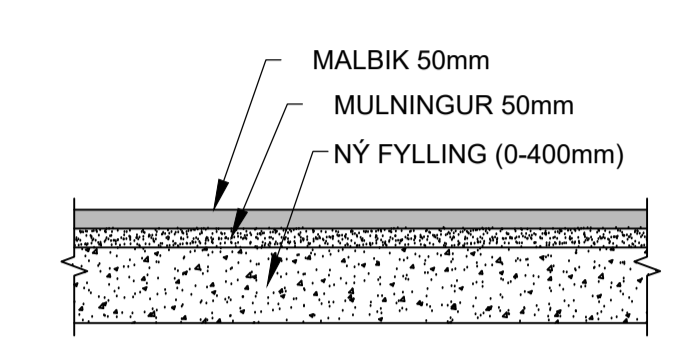

UPPBYGGING MALBIKAÐS PLANS  
1:20

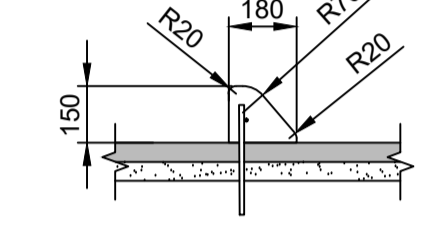

KANTSTEINN  
1:20

- SKÝRINGAR
- KANTSTEINN
  - HELLUR BÍLASTÆÐI
  - HELLUR
  - NYTT MALBIK

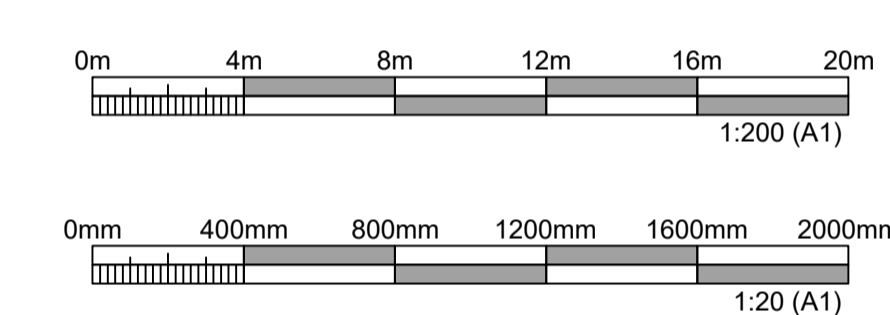

ÚTGÁFUFERILL					
ÚTG.	DAGS.	SKÝRINGAR	HANNAÐ	YFIRF.	SAMB.
01	22.11.2024	VERKTEIKNING	AP	BS	AMS
DAGS. UNDIRSKRIFTAR		F.H. MANNVITS (NAFN OG KT.)			
22.11.2024		Andri Martin Sigurðsson, kt: 170583-4429 anmsn@cowi.com			
DAGS. UNDIRSKRIFTAR		SAMRÆMINGARHÖNNUÐUR / HÖNNUNARSTJÓRI (NAFN OG KT.)			
22.11.2024		Andri Martin Sigurðsson, kt: 170583-4429 anmsn@cowi.com			

BYGGT Á ADALUPPDRATTUM - DAGS.: 11.06.2024 - ÚTGÁFA: 01



HEITI VERKS  
**COLAS ÞJÓNUSTU- OG STARFSMANNAHÚS  
GULLHELLA 1  
221 - HAFNARFJÖRÐUR**

HEITI TEKNINGAR  
**FRÁANGUR LÓÐAR  
ÞJÓNUSTUPLAN  
YFIRBORD OG SNID**

FRUMÚTGÁFA	MKV.	STÆRD	
22.11.2024		A1	
VERKNÚMÉR	VERKHLUTI	TEKNINGANÚMÉR	ÚTGÁFA
2.110.192	000	HDR-1004	01